



上海三曦

专注-专业-快好省

www.sanxxx.com

BIG FOOT SYSTEMS

Rooftop building services support systems



www.sanxxx.com





TM

ANCILLARIES

Product selector	4-5
H Frame Set 305mm (12")	6
H Frame Set 450mm (18")	7
H Frame Set 600mm (24")	7
Multi Foot	8
Fix-it Foot	9
High Bloc	9
AV Pads	10
Vibromat	10
Mounting Platforms	11
Swan Necks	11

AC SUPPORT SYSTEMS

Product selector	12-13
Mini Split Kit	14
Lock 'n' Load	15
Mini Split Stand Range	16
VRF/VRV Stand Range	17
Multi Frame	18
Standard Frames	19
Bespoke Frames	20

AHU SUPPORT SYSTEMS

Standard Frames	23
Bespoke Frames	24
HD Beams	25

CHILLERS

HD Cube	27
HD Beam	28
Bespoke Frames	29

SAFE ACCESS

Step Overs	31
Rapid Walkway	32
Plant Deck Frame	33





WHAT'S ON YOUR ROOF?



ANCILLARIES RANGE

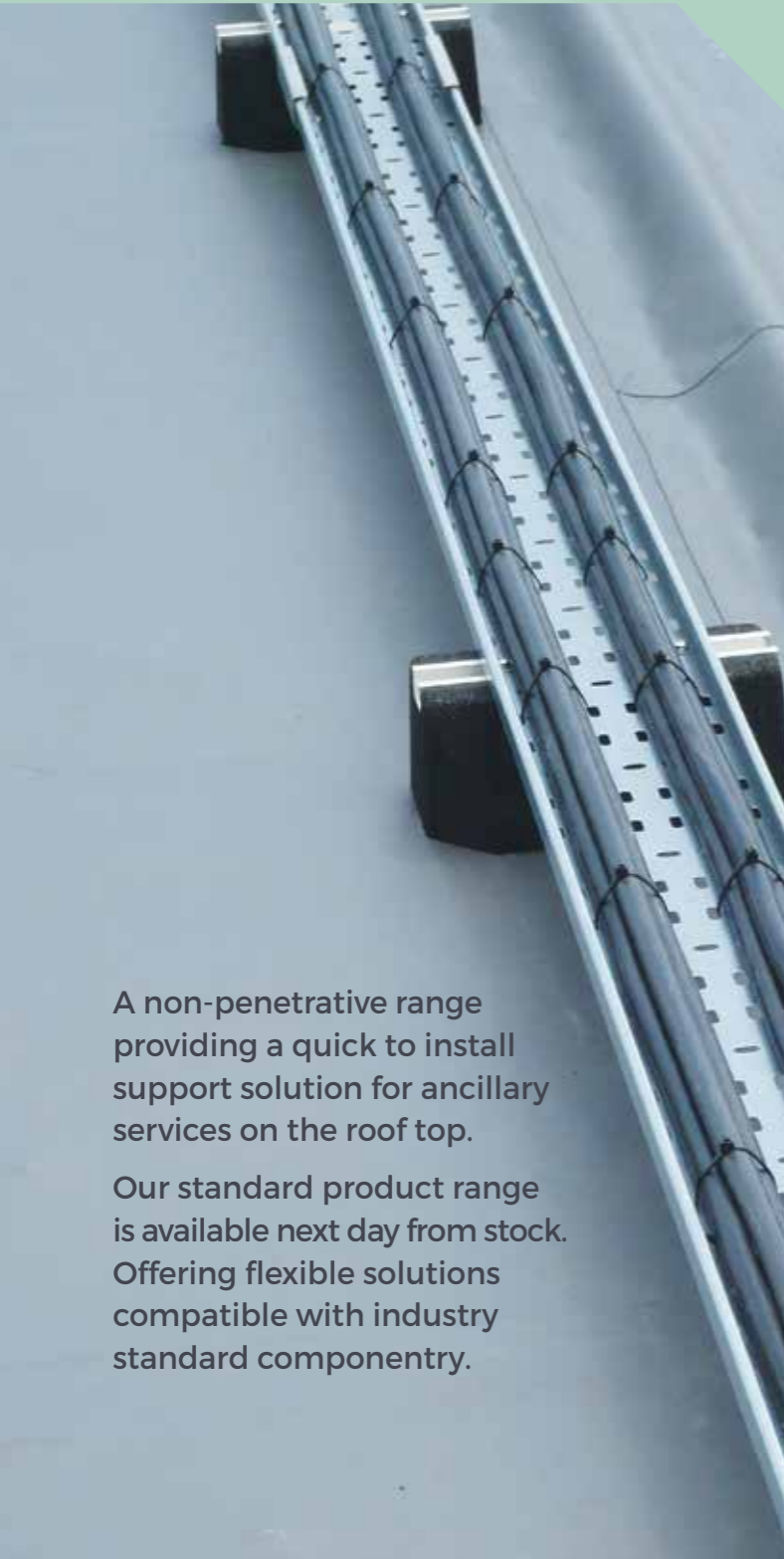

Find the best solution for supporting services on your roof top using the simple Big Foot Systems Ancillaries range selector...

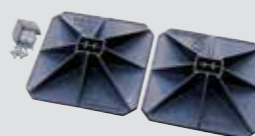
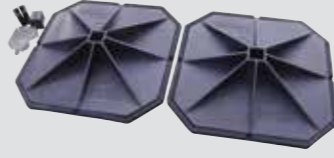

A non-penetrative range providing a quick to install support solution for ancillary services on the roof top.
Our standard product range is available next day from stock. Offering flexible solutions compatible with industry standard componentry.

SELECTOR		 H Frame Set 305 Page 6	 H Frame Set 450 & 600 Page 7	 Fix-it Foot Page 8	 Multi Foot Page 9
ELECTRICAL	Cable Basket			✓	
	Small Cable Tray	✓		✓	✓
	Larger Cable Tray	✓	✓	✓	✓
	Cable Ladder		✓		
	*Bus Bars		✓		
DUCT	Small Duct	✓			✓
	*Larger Duct	✓	✓		
	*Attenuators, (Silencers)		✓		
PIPE	Small F&R Pipe			✓	✓
	Medium F&R Pipe	✓			✓
	Large F&R Pipe		✓		
	*Multiple Pipe Runs		✓		

*Weight dependant



H Frame Set 305mm (12")

H Frame Sets are an economical support solution for pipe or duct. They accept a range of strut, and by fabricating the frame on-site, they are the flexible choice



H FRAME SET

Description	Part no.	Foot Size		Weight		Max. Load	
		mm	Inches	Kg	Lbs	Kg	Lbs
305mm (12")	B6088	305	12	3.65	8	300	661
305mm (12") - 5 Pack	B9645	305	12	18.25	40	300	661

FEATURES

- 305mm (12") feet
- Interchangeable with three strut* sizes:
21 × 41mm (13/16 × 1 5/8")
40 × 38mm (1 9/16 × 1 1/2")
41 × 41mm (1 5/8 × 1 5/8")
- Versatile application
- Adhered rubber mats provide additional roof protection
- Boxed for convenience

APPLICATION



* Please note: Strut is not included in kit, and is shown as an example

KIT INCLUDES

Foot with adhered mat	× 2
Bracket & fixings	× 4
Assembly instructions	× 1

H Frame Set 450mm (18") 600mm (24")

Where a greater load distribution is required for applications such as large ductwork, 450mm (18") or 600mm (24") H Frame Sets are also available

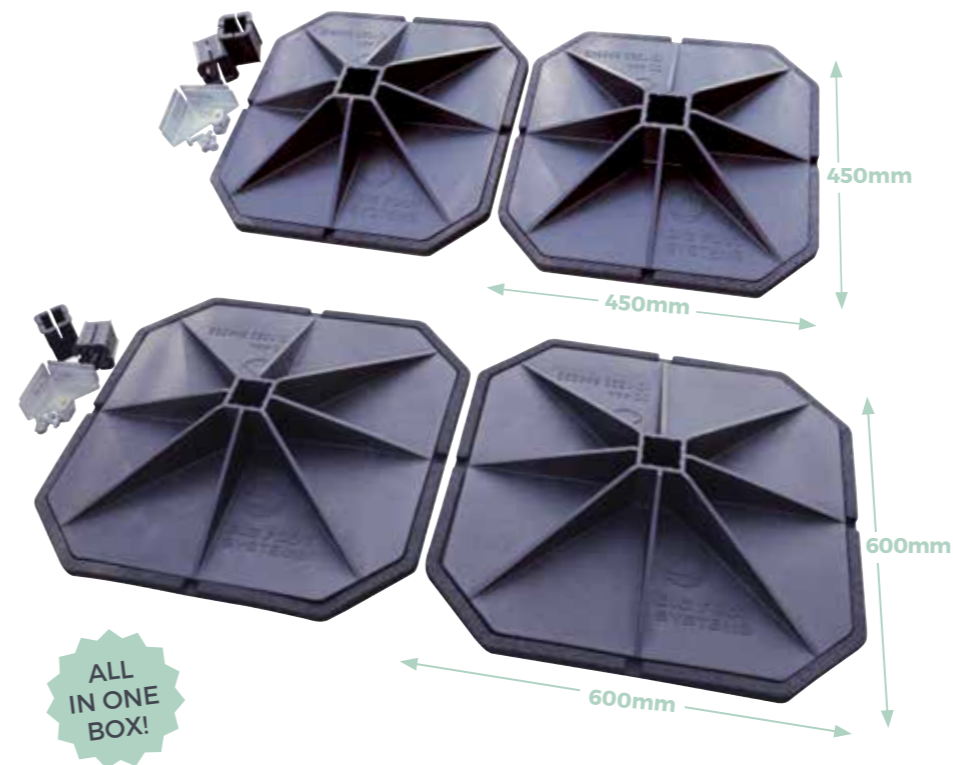

ALL IN ONE BOX!

H FRAME SET

Description	Part no.	Foot Size		Weight		Max. Load	
		mm	Inches	Kg	Lbs	Kg	Lbs
450mm (18")	B6089	450	17 1/4	14	31	500	1102
600mm (24")	B9222	600	23 3/4	25	55	500	1102

FEATURES

- 450mm (18") or 600mm (24") feet
- Suits 41 × 41mm (1 5/8 × 1 5/8") strut*
- Excellent load distribution
- Versatile application
- Rubber mats provide additional roof protection
- Boxed for convenience

APPLICATION



* Please note: Strut is not included in kit, and is shown as an example

KIT INCLUDES

Foot	× 2
Rubber mat	× 2
Strut Insert	× 2
Bracket & fixings	× 2
Assembly instructions	× 1





Multi Foot

Multi Foot is a multi-purpose support for cable tray or pipe. Used with channel, strut or threaded rod, this simple nylon foot is both versatile and economical



FEATURES

- Quick and easy install
- Available in 2 sizes
- Rigid nylon foot
- Versatile application using channel, strut or threaded rod
- Accepts a full range of strut sizes
- Adhered rubber mats provide additional roof protection
- Boxed for convenience

APPLICATION



* Please note: Strut, channel & rod is not included, and is shown as an example



ALL IN ONE BOX!

MULTI FOOT PACKS

Description	Part no.	Length		Width		Height		Weight		Max. Load	
		mm	Inches	mm	Inches	mm	Inches	Kg	Lbs	Kg	Lbs
400mm (16") - 4 Pack	B9640	400	15 3/4	180	7 1/8	80	3 1/8	6	13.2	259	571
600mm (24") - 3 Pack	B9655	600	23 5/8	220	8 1/8	80	3 1/8	11.7	25.7	474	1045

Fix-it Foot & High Bloc

The neat and tidy rubber Fix-it Foot is simple, durable and comes in a variety of sizes. Extra clearance can be created using a High Bloc which fits underneath



FEATURES

- Quick and simple install
- Aluminium channel securley anchored in top for easy fixing of services
- Wide range of height and length options available
- Durable recycled rubber reduces vibration and adds stability

FIX-IT FOOT

Description	Part no.	Length		Width		Height		Weight		Max. Load	
		mm	Inches	mm	Inches	mm	Inches	Kg	Lbs	Kg	Lbs
250 (10")	B6735	250	9 13/16	180	7 1/8	95	3 3/4	2.4	5.3	82	181
400 (16")	B6736	400	15 3/4	180	7 1/8	95	3 3/4	3.5	7.8	128	282
600 (24")	B6737	600	23 5/8	180	7 1/8	95	3 3/4	5.8	12.7	224	494
1000 (40")	B9096	1000	39 3/8	180	7 1/8	95	3 3/4	9.9	21.9	295	650
250 (10") Low	B9043	250	9 13/16	130	5 1/8	50	1 13/16	1.3	2.9	82	181
400 (16") Low	B9045	400	15 3/4	130	5 1/8	50	1 13/16	2.1	4.5	128	282
500 (20") Low	B9368	500	19 1/16	130	5 1/8	50	1 13/16	2.5	5.4	134	295
600 (24") High Bloc	B6974	600	23 5/8	180	7 1/8	120	4 3/4	10.2	22.4	224	494
1000 (40") High Bloc	B6973	1000	39 3/8	180	7 1/8	120	4 3/4	17.7	38.9	295	650



AV Pads

AV Pads come in a range of sizes and offer isolation against vibration between the unit and the Big Foot Frame

FEATURES

- Anti-vibration core
- Outer layer corrugated anti-slip rubber
- Available in 6 sizes

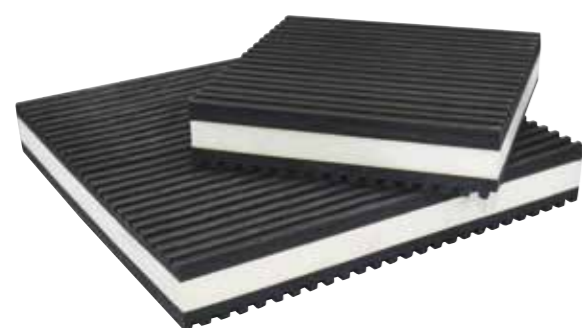

AV PADS

Description	Part no.	Length		Width		Height	
		mm	Inches	mm	Inches	mm	Inches
51mm (2")	B6909	51	2	51	2	22.2	¾
76mm (3")	B6910	76	3	76	3	22.2	¾
101mm (4")	B6911	101	4	101	4	22.2	¾
152mm (6")	B6912	152	6	152	6	22.2	¾
305mm (12")	B6913	305	12	305	12	22.2	¾
457mm (18")	B6914	457	18	457	18	22.2	¾

Mounting Platforms

A simple platform support using either our 305mm (12") or 450mm (18") feet, available with a plain, 2 or 4 sided top

FEATURES

- Simple and versatile kit
- Central M10 threaded insert on the platform



MOUNTING PLATFORMS

Description	Part no.	Useable Area	
		mm	Inches
305mm (12") Plain Top	B9098	126 × 126	5 × 5
305mm (12") 2 Sides	B9099	114 × 126	4 ½ × 5
305mm (12") 4 Sides	B9100	114 × 114	4 ½ × 4 ½
450mm (18") Plain Top	B9101	126 × 126	5 × 5
450mm (18") 2 Sides	B9102	114 × 126	4 ½ × 5
450mm (18") 4 Sides	B9103	114 × 114	4 ½ × 4 ½

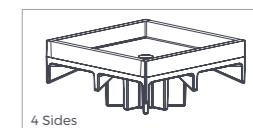
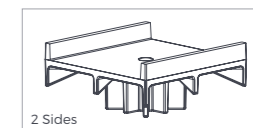
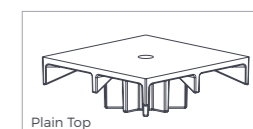

KIT INCLUDES

- Platform × 2
- Foot & mat × 2

Vibromats

A range of durable rubber mats that can lay directly on the rooftop to protect it from potential damage from foot fall and ancillary equipment

FEATURES

- Ideal for walkways and to protect roof surfaces
- Durable recycled rubber reduces vibration
- 5 options available*

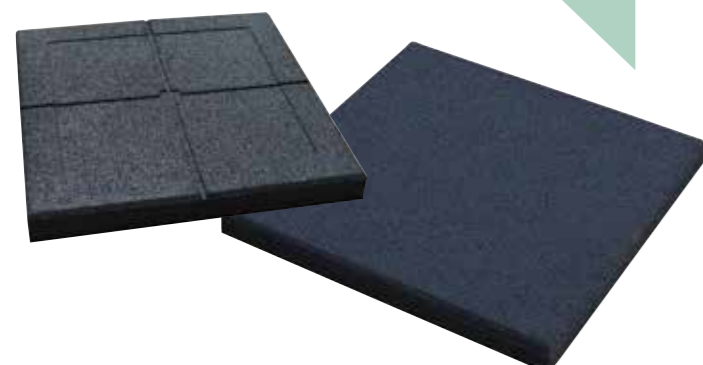

VIBROMATS

Description	Part no.	Length		Width		Height	
		mm	Inches	mm	Inches	mm	Inches
Small Strip*	B6491	600	23 ¾	150	5 ¾	30	1 ¾
Large Strip*	B6282	1000	39 ¾	500	19 ½	30	1 ¾
Plain Tile 400	B9641	400	15 ¾	400	15 ¾	36	1 ½
Plain Tile 500	B6416	500	19 ½	500	19 ½	45	1 ¾
Plain Strip	B6024	1000	39 ¾	75	3	15	¾

*NOTE: Small Strip and Large Strip include 2 no. steel plate core at either end

Swan Necks

When penetrating the roof with cable or pipe runs, our Swan Necks make a full seal with the roof membrane

FEATURES

- Lightweight aluminium
- Full hood to protect against rain ingress
- Range of sizes

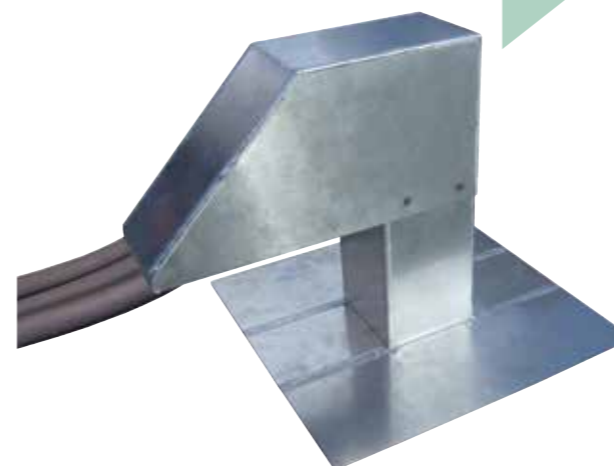

SWAN NECKS

Description	Part no.	Outlet Size		No. of Outlets	Height	
		mm	Inches		mm	Inches
Square Small	B9154	75 × 75	3 × 3	1	484	15 ¾
Square Medium	B9148	125 × 125	5 × 5	1	484	15 ¾
Square Large	B9149	200 × 200	8 × 8	1	484	15 ¾
Oblong Small	B9150	125 × 250	5 × 10	1	484	15 ¾
Oblong Double	B9152	125 × 250	5 × 10	2	484	15 ¾
Oblong Large	B9151	125 × 500	5 × 20	1	484	15 ¾



AIR CONDITIONING RANGE







Our range provides a quick to install, non-penetrative solution to suit all leading AC manufacturers units.

Our standard product range is available next day from stock. With an ever increasing number of AC manufacturers, our Bespoke Frames are dimensionally configurable at design stage and utilise standard componentry.

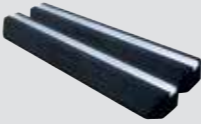

AIR CONDITIONING RANGE

Find the Big Foot Systems product - best suited for the Air Conditioning units you wish to support - using this simple selector...

SELECTOR	 Mini Split Kit Pages 14	 Lock 'n' Load Page 15	 Mini Split Stand Range Page 16	 VRF/VRV Stand Range Page 17	 Multi Frame Page 18	 Standard Frames Page 19	 Bespoke Frames Page 20
1-2 No. A/C Split units	✓	✓	✓		✓	✓	✓
3-4 No. A/C Split units		✓	✓		✓	✓	✓
5-6 No. A/C Split units		✓	✓		✓	✓	✓
7+ A/C Split units		✓	✓		✓		✓
1 No. VRF/VRV unit*				✓	✓	✓	✓
2 No. VRF/VRV units*				✓	✓	✓	✓
3 No. VRF/VRV units*				✓	✓	✓	✓
4 + VRF/VRV units*				✓	✓		✓

* Based on typical carcass size of 990mm x 760mm (39" x 29 1/2")



Mini Split Kit

The Mini Split Kit is a simple and neat solution. With channel recessed into the rubber foot, it allows for easy fixing and also offers built-in anti-vibration



FEATURES

- Available in 2 sizes
- Boxed kit with fixings
- Quick and simple install
- Aluminium channel securely anchored in top for easy fixing of unit
- Durable recycled rubber reduces vibration and adds stability



KIT INCLUDES

- Rubber Foot × 2
- Fixing kit × 2

MINI SPLIT KIT

Description	Part no.	Length		Width		Height		Weight		Max. Load	
		mm	Inches	mm	Inches	mm	Inches	Kg	Lbs	Kg	Lbs
600mm (24")	B9284	600	23 3/8"	180	7 1/8"	95	3 3/4"	11	12.1	448	494
1000mm (40")	B9530	1000	39 3/8"	180	7 1/8"	95	3 3/4"	19	20.9	590	650

AIR CONDITIONING RANGE

Lock 'n' Load

With its unique design, the Lock 'n' Load combines a steel frame and reinforced plastic connectors, offering flexibility and a quick installation - in one box!

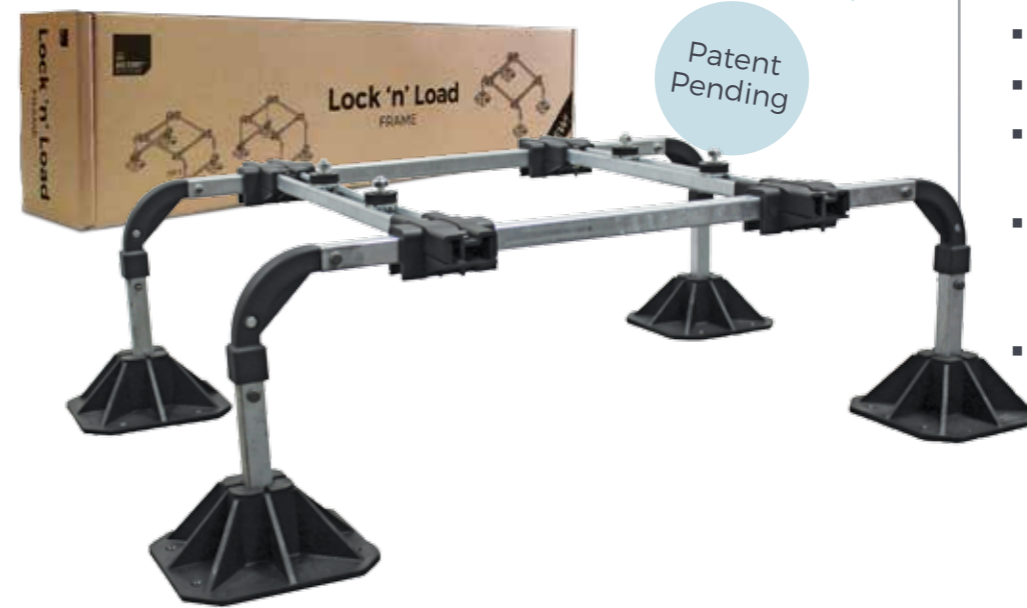

Patent Pending



FEATURES

- 200mm (8") Feet
- 3 heights available with optional Extender Kits
- Fast assembly
- Fully adjustable cross bars
- Support individual or multiple mini split units
- Galvanized steel frame with reinforced plastic connectors
- Anti-vibration mounts

LOCK 'N' LOAD FRAME

Description	Part no.	Length		Width		Height		Weight		Max. Load	
		mm	Inches	mm	Inches	mm	Inches	Kg	Lbs	Kg	Lbs
Low Frame	B5623	1096	43 1/8"	767	30 3/8"	305	12"	9.9	22	150	331
Medium Frame	B5625	1096	43 1/8"	767	30 3/8"	450	18"	13.5	30	150	331
High Frame	B5627	1096	43 1/8"	767	30 3/8"	600	24"	14.4	32	150	331
Low Extender	B5624	1096	43 1/8"	820	32 3/8"	305	12"	7.5	17	150	331
Medium Extender	B5626	1096	43 1/8"	820	32 3/8"	450	18"	11	24	150	331
High Extender	B5628	1096	43 1/8"	820	32 3/8"	600	24"	11.5	25	150	331
Tower	B5629	1096	43 1/8"	767	30 3/8"	305 & 1426	12 & 56"	26.2	58	150 & 150	331 & 331

KIT INCLUDES

Description	Frame	Ext.	Tower
200mm (8") Foot & insert	× 4	× 2	× 4
End bar assembly	× 2	× 1	× 2
Cross bar assembly	× 2	× 2	× 4
Assembly fixing kit	× 2	× 2	× 4
Mounting fixing kit (2 pack)	× 2	× 2	× 4



Mini Split Stand Range

The Mini Split Stand Range is available in a variety of frame sizes to suit a single unit or, with the addition of extender kits, you can support multiple mini splits



FEATURES

- 200mm (8") Feet
- Available in 3 heights
- Optional Extender Kits and Risers
- Support individual or multiple mini split units
- Adjustable slotted channel cross bar, to suit industry standard fixings
- Anti-vibration mounts
- Quick to assemble

MINI SPLIT STAND RANGE

Description	Part no.	Length		Width		Height		Weight		Max. Load	
		mm	Inches	mm	Inches	mm	Inches	Kg	Lbs	Kg	Lbs
Low	B5550	475	18 1/16	419 - 619	16 1/2 - 24 3/8	305	12	20	44	175	385
High	B5551	475	18 1/16	419 - 619	16 1/2 - 24 3/8	450	17 1/16	22	49	175	385
Tower	B5552	475	18 1/16	419 - 619	16 1/2 - 24 3/8	305 & 1000	12 & 39 3/8	35	77	300	661
Low Extender	B5553	950	37 3/8	419 - 619	16 1/2 - 24 3/8	305	12	18	40	175	385
High Extender	B5554	950	37 3/8	419 - 619	16 1/2 - 24 3/8	450	17 1/16	19	42	175	385
Riser (4 Pack)	B5555	-	-	-	-	152	6	1.5	3	-	-
Riser (2 Pack)	B5562	-	-	-	-	152	6	0.75	2	-	-

KIT INCLUDES

Description	Frame	Ext.	Tower
200mm (8") Foot & insert	× 4	× 2	× 4
End bar	× 2	× 1	× 2
Cross bar	× 2	× 2	× 4
Fixing kit	× 4	× 4	× 8

VRF/VRV Stand Range

The Stand Range is a versatile ground mount frame system, and with the optional Extender Kits, it is compatible with all leading VRF/VRV units



FEATURES

- 200mm (8") Feet
- Available in 3 lengths
- Optional Extender Kits
- Support individual or multiple VRF/VRV units
- Adjustable slotted channel cross bar, to suit industry standard fixings
- Clamp kits
- Quick to assemble

VRF/VRV STAND RANGE

Description	Part no.	Length		Width		Height		Weight		Max. Load	
		mm	Inches	mm	Inches	mm	Inches	Kg	Lbs	Kg	Lbs
990 (38") Frame	B5556	990	32 3/8	620 - 780	24 3/8 - 30 1/16	305	12	35	77	600	1323
1290 (51") Frame	B5557	1290	44 1/4	620 - 780	24 3/8 - 30 1/16	305	12	38	84	500	1102
1450 (57") Frame	B5558	1450	50 3/8	620 - 780	24 3/8 - 30 1/16	305	12	41	90	400	882
990 (38") Extender	B5559	990	32 3/8	620 - 780	24 3/8 - 30 1/16	305	12	25	55	600	1323
1290 (51") Extender	B5560	1290	44 1/4	620 - 780	24 3/8 - 30 1/16	305	12	28	62	500	1102
1450 (57") Extender	B5561	1450	50 3/8	620 - 780	24 3/8 - 30 1/16	305	12	31	68	400	882

KIT INCLUDES

Description	Frame	Ext.
200mm (8") Foot & insert	× 4	× 2
End bar	× 2	× 1
Cross bar	× 2	× 2
Fixing kit	× 4	× 4



AHU SUPPORT RANGE

Our packaged standardised approach is delivered to site, with the systems requiring minimal on-site assembly and, without the need to penetrate the roof, are easily positioned.

Where the install requires, we also offer a bespoke solution which is dimensionally configurable at design stage, in footprint and height.



AIR HANDLERS RANGE

Standard Frame

The Standard Frames are available from stock in 1m (40"), 2m (80") and 3m (120") arrangements, for the support of small Air Handlers

FEATURES

- Adjustable leg assemblies
- 3 lengths available
- 1.2m (48") or 1.5m (60") cross bars
- Simple to assemble
- Supplied boxed with clamp kits



STANDARD FRAMES

Description	Part no.	Length		Width		Height		Weight		Max. Load	
		mm	Inches	mm	Inches	mm	Inches	Kg	Lbs	Kg	Lbs
1m x 1.2m (40" x 48")	B6075	1000	39 3/8"	1200	47 1/4"	290 - 400	11 3/8" - 15 3/8"	39	86	500	1102
2m x 1.2m (80" x 48")	B6077	2000	78 3/4"	1200	47 1/4"	290 - 400	11 3/8" - 15 3/8"	67	148	1000	2205
3m x 1.2m (120" x 48")	B6078	3000	118 1/8"	1200	47 1/4"	290 - 400	11 3/8" - 15 3/8"	97	214	1500	3307
1m x 1.5m (40" x 60")	B9442	1000	39 3/8"	1500	59 1/8"	290 - 400	11 3/8" - 15 3/8"	42	93	400	882
2m x 1.5m (80" x 60")	B9443	2000	78 3/4"	1500	59 1/8"	290 - 400	11 3/8" - 15 3/8"	72	159	800	1764
3m x 1.5m (120" x 60")	B9444	3000	118 1/8"	1500	59 1/8"	290 - 400	11 3/8" - 15 3/8"	103	227	1200	2646

KIT INCLUDES

- 40mm x 40mm (1 1/2" x 1 1/2") box section end bars
- Cross bars
- 305mm (12") Leg assemblies
- Clamp kits
- Assembly instructions



Bespoke Frames

Bespoke Frames are configured in footprint and height, from our standard componentry, offering a free-standing solution to suit your specific project needs

FEATURES

- 3 Leg assembly heights
- 3 Cross bar sizes
- Frame width range from 0.9m (36") to 3.5m (138")

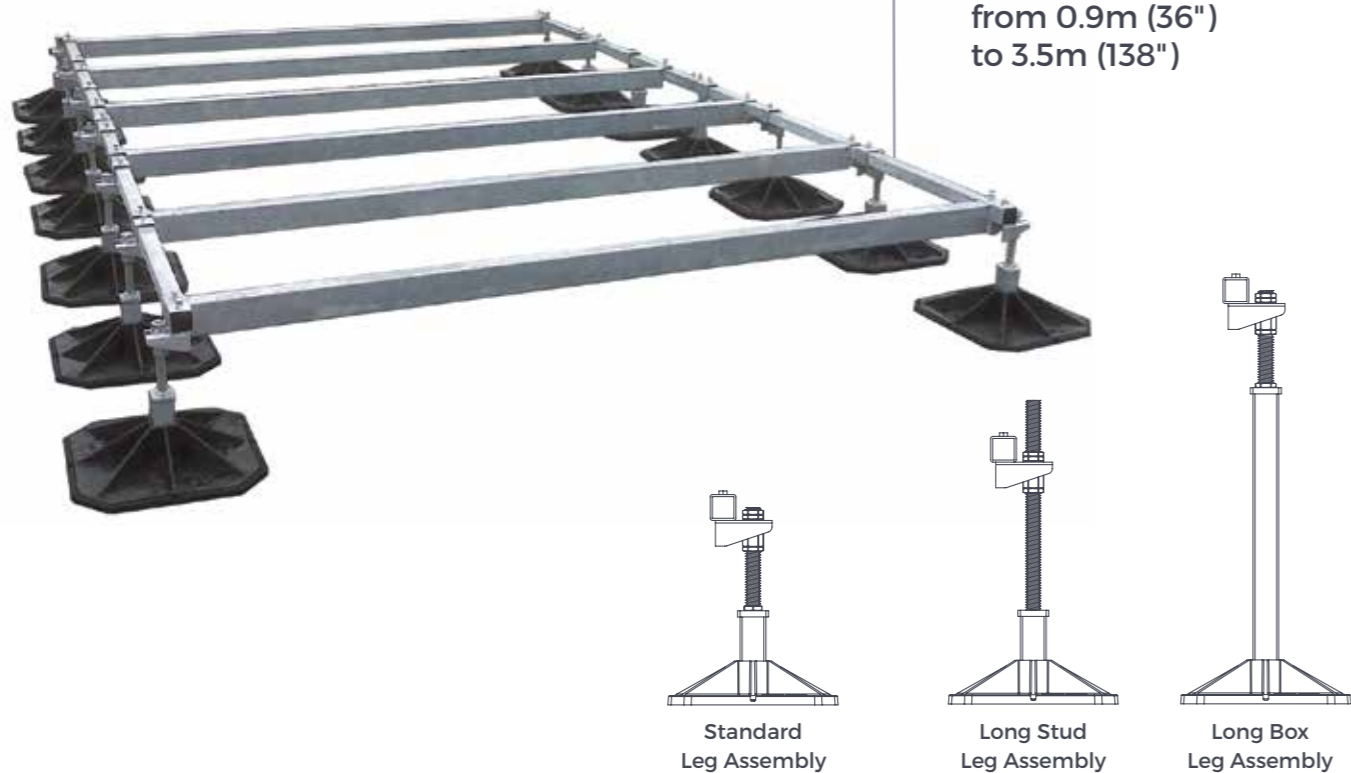

Standard Leg Assembly

Long Stud Leg Assembly

Long Box Leg Assembly

CROSS BAR OPTIONS

Section		Range of Sizes	
mm	Inches	mm	Inches
40 x 40	1 5/8 x 1 5/8	900 - 1500	36 - 60
50 x 50	2 x 2	1500 - 2100	60 - 83
100 x 50	4 x 2	1600 - 3500	66 - 138

LEG ASSEMBLY OPTIONS

Description	Height Adjustment	
	mm	Inches
Standard Leg Assembly	290 - 400	11 3/8 - 15 3/4
Long Stud Leg Assembly	290 - 610	11 3/8 - 24
Long Box Leg Assembly	730 - 825	28 3/4 - 32 1/2

AIR HANDLERS RANGE

HD Beams

The HD Beam enables the AHU to be positioned accurately, such as directly over existing structural beams, so the load can be evenly distributed

FEATURES

- Adjustable height
- Standard or Long Stud leg assemblies
- Available with 305mm (12"), 450mm (18") or 600mm (24") feet
- Supplied boxed with beam clamps



B5104 HD Mounting Plate

B9306 HD Clamp

HD BEAM

Description	Part no.	Length		Width		Height		Weight		Max. Load	
		mm	Inches	mm	Inches	mm	Inches	Kg	Lbs	Kg	Lbs
360/305 (14"/12")	B9722	1066	42	330	13	300 - 360	11 3/8 - 14 3/8	16	35	500	1102
560/305 (22"/12")	B9723	1066	42	330	13	300 - 560	11 3/8 - 22 1/8	18	40	500	1102
360/450 (14"/18")	B9423	1222	48 1/2	486	19 1/2	300 - 360	11 3/8 - 14 3/8	23	51	1000	2205
560/450 (22"/18")	B9690	1222	48 1/2	486	19 1/2	300 - 560	11 3/8 - 22 1/8	25	55	1000	2205
360/600 (14"/24")	B9373	1378	54 1/4	642	25 1/4	300 - 360	11 3/8 - 14 3/8	33	73	1500	3307
560/600 (22"/24")	B9692	1378	54 1/4	642	25 1/4	300 - 560	11 3/8 - 22 1/8	35	77	1500	3307

KIT INCLUDES

Leg assembly	× 2
Cross bar	× 1
Beam clamps	× 2
Assembly instructions	× 1



CHILLER SUPPORT RANGE

Our range provides a highly effective support solution for the unique heavy duty requirements of a chiller.

Offering unparalleled load distribution and the ability to accurately position the chiller directly over existing structural roof beams when required, our support systems offer the best solution every time.

CHILLER RANGE

HD Cube

Due to the close proximity of the four feet, the HD Cube has a large square base which naturally affords excellent load distribution qualities

FEATURES

- Available in 9 configurations
- Available with 305mm (12"), 450mm (18") or 600mm (24") feet
- Alternative to heavy complex frameworks
- Fast assembly
- Excellent load distribution
- Supplied boxed



B5104
HD Mounting Plate

B9306
HD Clamp

HD CUBE

Description	Part no.	Length		Width		Height		Weight		Max. Load	
		mm	Inches	mm	Inches	mm	Inches	Kg	Lbs	Kg	Lbs
360/305	B5611	1066	42	979	38 1/2	350 - 410	13 3/4 - 16 1/8	39	86	1000	2205
560/305	B5612	1066	42	979	38 1/2	350 - 610	13 3/4 - 24	42	93	1000	2205
800/305	B5613	1066	42	979	38 1/2	800 - 860	31 1/2 - 33 3/4	48	106	1000	2205
360/450	B5614	1222	48 1/2	1135	44 3/4	350 - 410	13 3/4 - 16 1/8	52	115	2000	4409
560/450	B5615	1222	48 1/2	1135	44 3/4	350 - 610	13 3/4 - 24	56	123	2000	4409
800/450	B5616	1222	48 1/2	1135	44 3/4	800 - 860	31 1/2 - 33 3/4	64	141	2000	4409
360/600	B5617	1378	54 1/4	1291	50 3/4	350 - 410	13 3/4 - 16 1/8	74	163	3000	6614
560/600	B5618	1378	54 1/4	1291	50 3/4	350 - 610	13 3/4 - 24	76	168	3000	6614
800/600	B5619	1378	54 1/4	1291	50 3/4	800 - 860	31 1/2 - 33 3/4	83	183	3000	6614

KIT INCLUDES

Adjustable leg	× 4
Cube end bar	× 2
Cube cross bar	× 1
Assembly instructions	× 1



HD Beam

The HD Beam enables the heavy plant to be positioned accurately, such as directly over existing structural beams, so the load can be evenly distributed



B5104
HD Mounting Plate

B9306
HD Clamp

FEATURES

- Adjustable height
- Standard or Long Stud leg assemblies
- Available with 305mm (12"), 450mm (18") or 600mm (24") feet
- Supplied boxed with beam clamps

CHILLER RANGE

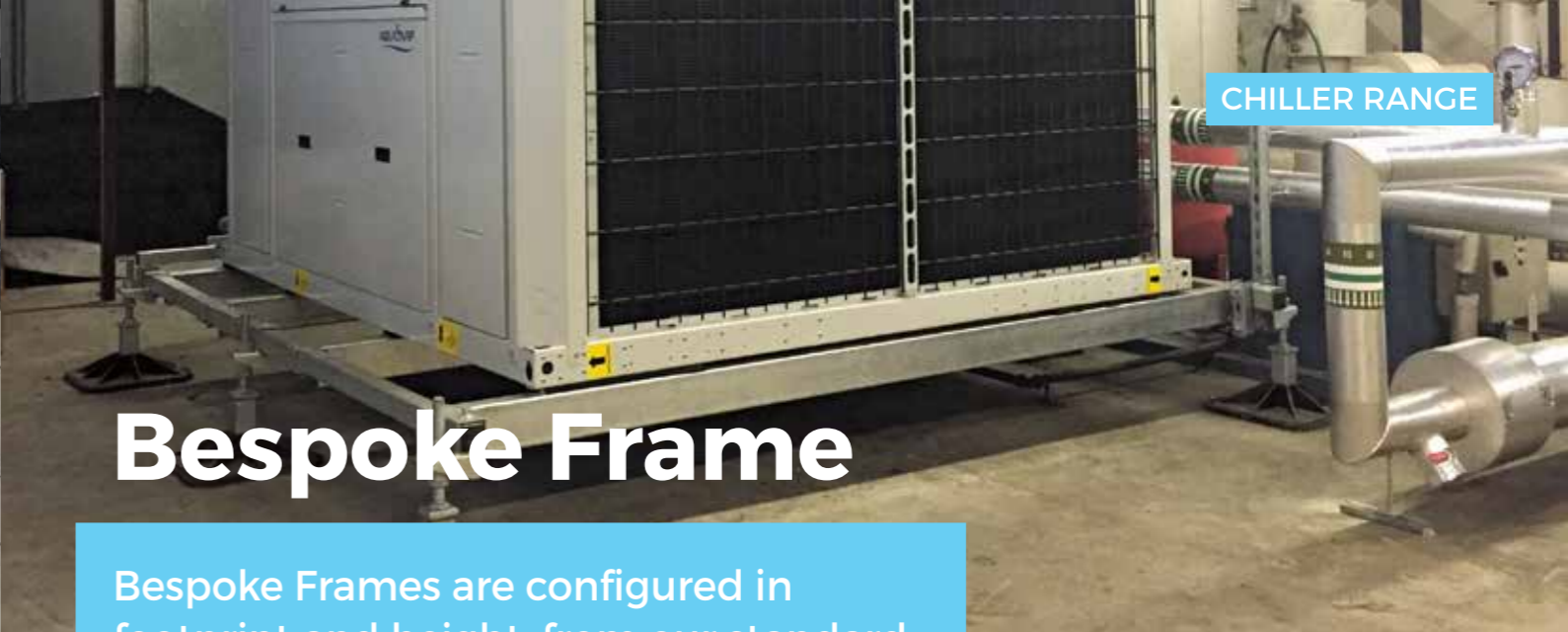

Bespoke Frame

Bespoke Frames are configured in footprint and height, from our standard componentry, offering a free-standing solution to suit your specific project needs



FEATURES

- 3 Leg assembly heights
- 3 Cross bar sizes
- Frame width range from 0.9m (36") to 3.5m (138")

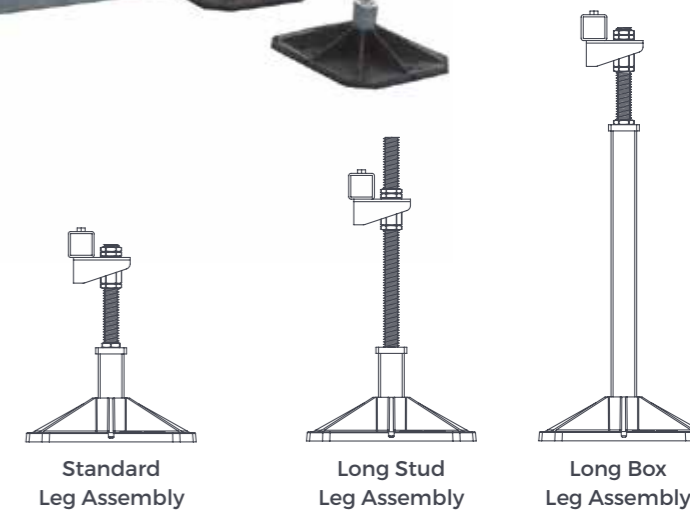

Standard Leg Assembly

Long Stud Leg Assembly

Long Box Leg Assembly

HD BEAM

Description	Part no.	Length		Width		Height		Weight		Max. Load	
		mm	Inches	mm	Inches	mm	Inches	Kg	Lbs	Kg	Lbs
360/305 (14"/12")	B9722	1066	42	330	13	300 - 360	11 1/16 - 14 3/16	16	35	500	1102
560/305 (22"/12")	B9723	1066	42	330	13	300 - 560	11 1/16 - 22 1/16	18	40	500	1102
360/450 (14"/18")	B9423	1222	48 1/2	486	19 1/2	300 - 360	11 1/16 - 14 3/16	23	51	1000	2205
560/450 (22"/18")	B9690	1222	48 1/2	486	19 1/2	300 - 560	11 1/16 - 22 1/16	25	55	1000	2205
360/600 (14"/24")	B9373	1378	54 1/4	642	25 1/4	300 - 360	11 1/16 - 14 3/16	33	73	1500	3307
560/600 (22"/24")	B9692	1378	54 1/4	642	25 1/4	300 - 560	11 1/16 - 22 1/16	35	77	1500	3307

KIT INCLUDES

Leg assembly	× 2
Cross bar	× 1
Beam clamps	× 2
Assembly instructions	× 1

CROSS BAR OPTIONS

Section		Range of Sizes	
mm	Inches	mm	Inches
40 × 40	1 1/16 × 1 1/16	900 - 1500	36 - 60
50 × 50	2 × 2	1500 - 2100	60 - 83
100 × 50	4 × 2	1600 - 3500	66 - 138

LEG ASSEMBLY OPTIONS

Description	Height Adjustment	
	mm	Inches
Standard Leg Assembly	290 - 400	11 1/16 - 15 3/4
Long Stud Leg Assembly	290 - 610	11 1/16 - 24
Long Box Leg Assembly	730 - 825	28 3/4 - 32 1/2



SAFE ACCESS RANGE

Offering secure and easy access to rooftop services the Safe Access range provides standard site-assembled Rapid Walkway, Step Overs and Plant Deck Frame.

In addition, Big Foot Systems highly skilled engineering team will survey and design Custom Safe Access systems tailored specifically to meet individual design parameters.



Step Overs

Step Overs are the ideal solution for safe and easy access around most obstacles and are available with 2, 3 and 4 steps and a 1m landing section

SAFE ACCESS RANGE



FEATURES

- 3 step options available
- 1m landing section
- Adjustable leg assemblies
- Flat packed for ease of handling
- Simple to assemble

STEP OVER PLATFORM

- 2 widths available with optional handrail
- 200mm feet
- 1m long landing section
- 155mm clearance height
- Simple to assemble

KIT INCLUDES

305mm (12") Leg assemblies	× 4
Step handrails	× 4
Step stringers	× 4
Step grating	× 4/6/8
Landing grating	× 1
Landing kick-plate	× 2
Landing handrails	× 2
Assembly instructions	× 1

STEP OVER

Description	Part no.	Length		Width		Clearance Height		Weight	
		mm	Inches	mm	Inches	mm	Inches	Kg	Lbs
2 Step Unit	B6939	2060	81 1/8	1472	56	1770	69 1/16	215	474
3 Step Unit	B6940	2560	100 1/16	1472	56	1990	78 3/8	255	562
4 Step Unit	B6941	3060	120 1/2	1472	56	2210	87	295	650

Description	Part no.
600 (24")	B9200
1000 (40")	B9201
Handrail	B6942

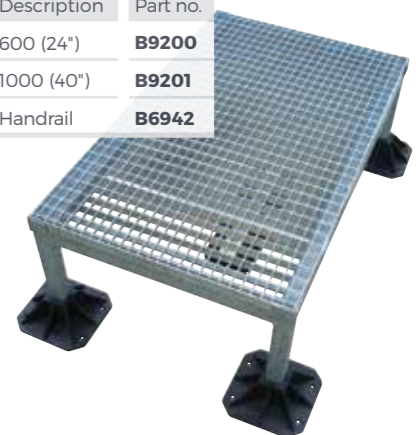



Rapid Walkway

Ideal for establishing a safe pathway around installations on a flat roof. The gritted GRP top is non-slip in any weather and supported by our durable Fix-it feet



FEATURES

- Fast installation
- Various length handrails available from stock
- Supported on Fix-it Foot for stability and reduced vibration
- Non-slip GRP walkway
- Flat packed for ease of handling

RAPID WALKWAY

Description	Part no.	Length		Width		Height		Weight	
		mm	Inches	mm	Inches	mm	Inches	Kg	Lbs
1m x 1m (40" x 40")	B9105	1000	39 3/8	1000	39 3/8	121	4 3/4	32	71
2m x 1m (80" x 40")	B9106	2000	78 3/4	1000	39 3/8	121	4 3/4	54	119
3m x 1m (120" x 40")	B9107	3000	118 1/8	1000	39 3/8	121	4 3/4	77	170
1m (40") Handrail	B9111	1000	39 3/8	-	-	1100	43 5/16	13	29
2m (80") Handrail	B9112	2000	78 3/4	-	-	1100	43 5/16	22	49
3m (120") Handrail	B9113	3000	118 1/8	-	-	1100	43 5/16	30	66
1m (40") Corner Handrail	B9104	1000	39 3/8	1000	39 3/8	1100	43 5/16	23	51

KIT INCLUDES

- Fix-it Foot 1000 feet
- GRP Grid
- Assembly instructions

Plant Deck Frame

Designed to facilitate multiple VRF/VRV installations with access requirements, available in 3 sizes, the wide base also offer stability in high wind locations

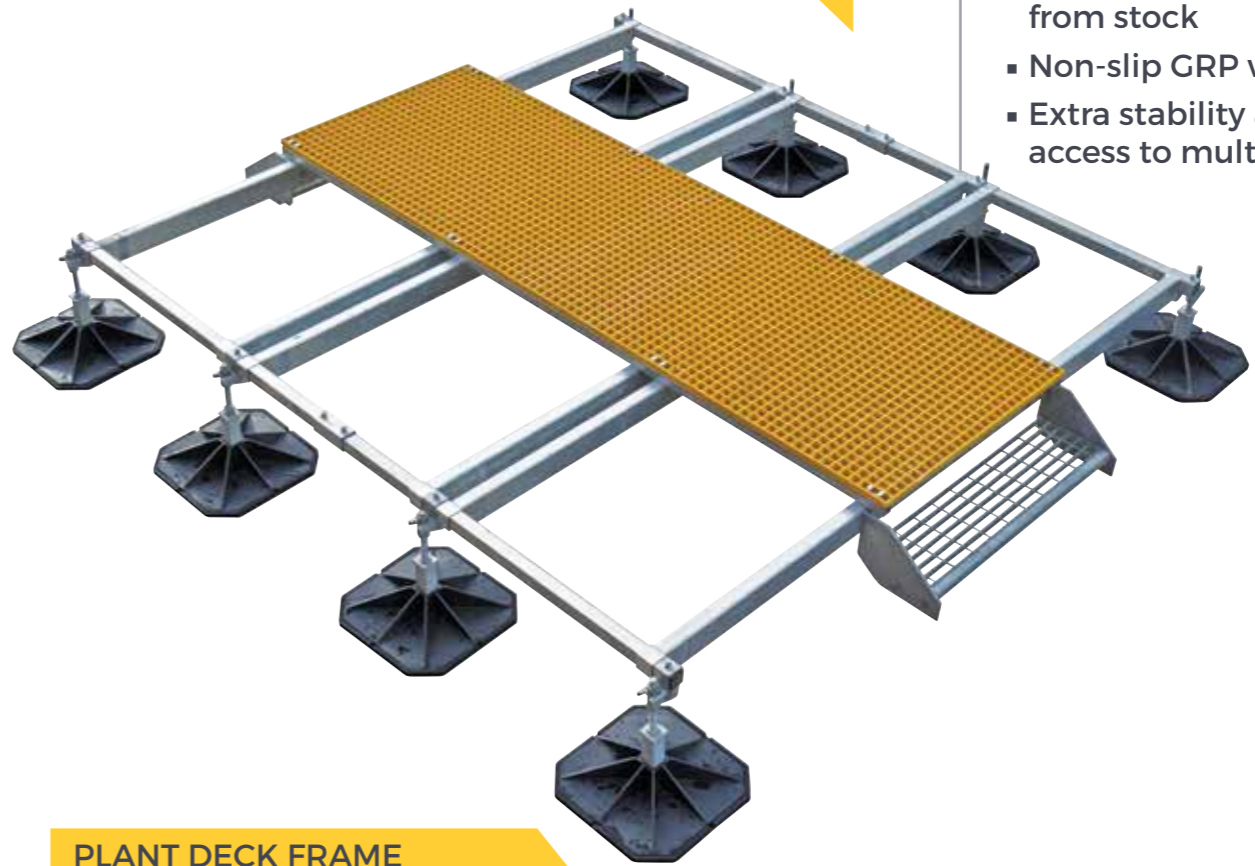

FEATURES

- Fast installation
- 3 standard sizes available from stock
- Non-slip GRP walkway
- Extra stability and easy access to multiple units

PLANT DECK FRAME

Description	Part no.	Length		Width		Height		Weight		Max. Load	
		mm	Inches	mm	Inches	mm	Inches	Kg	Lbs	Kg	Lbs
4 Unit	B4040	2436	95 1/16	3450	135 1/16	380 - 480	15 - 19	230	507	1600	3527
6 Unit	B4060	3436	135 1/16	3450	135 1/16	380 - 480	15 - 19	329	705	2400	5291
8 Unit	B4080	4436	174 1/16	3450	135 1/16	380 - 480	15 - 19	410	904	3200	7055

KIT INCLUDES

- Adjustable leg assemblies
- End bars
- Cross bars
- GRP Grid
- Assembly instructions

SAFE ACCESS RANGE



CUSTOM

For more complex applications, with the aid of highly skilled engineering team, we can design and manufacture complete one-off solutions. We are yet to encounter a scenario under which we haven't been able to design a solution. Contact our team today!



DISCLAIMER: We takes no responsibility for the condition of the roof on which our equipment is to be used. You must ensure that the substrate on which the Systems is intended for use is structurally sound enough to take the weight and point loadings we have indicated.

All our products must be installed in line with the guarantees and recommendations of the manufacturer of the roofing system. The manufacturer of PVC membranes should advise on the susceptibility to migration of plasticizers and specific recommendations should be adhered to so that the roof guarantee is not affected.